

Air-Vent Exteriors

GHRC-100



$\frac{1}{1}$
 Canopy Isometric View



GHRC-100

SCALE:N/A	APPROVED BY:	DRAWN BY: ES
DATE: 4/23/19		REVISION:
FOR:		Drawing Number: 1 of 13

THESE DRAWINGS WERE PREPARED BY AND ARE THE SOLE PROPERTY OF AIR-VENT EXTERIORS. UNAUTHORIZED USE OR REPRODUCTIONS IS STRICTLY PROHIBITED. AIR-VENT EXTERIORS ©

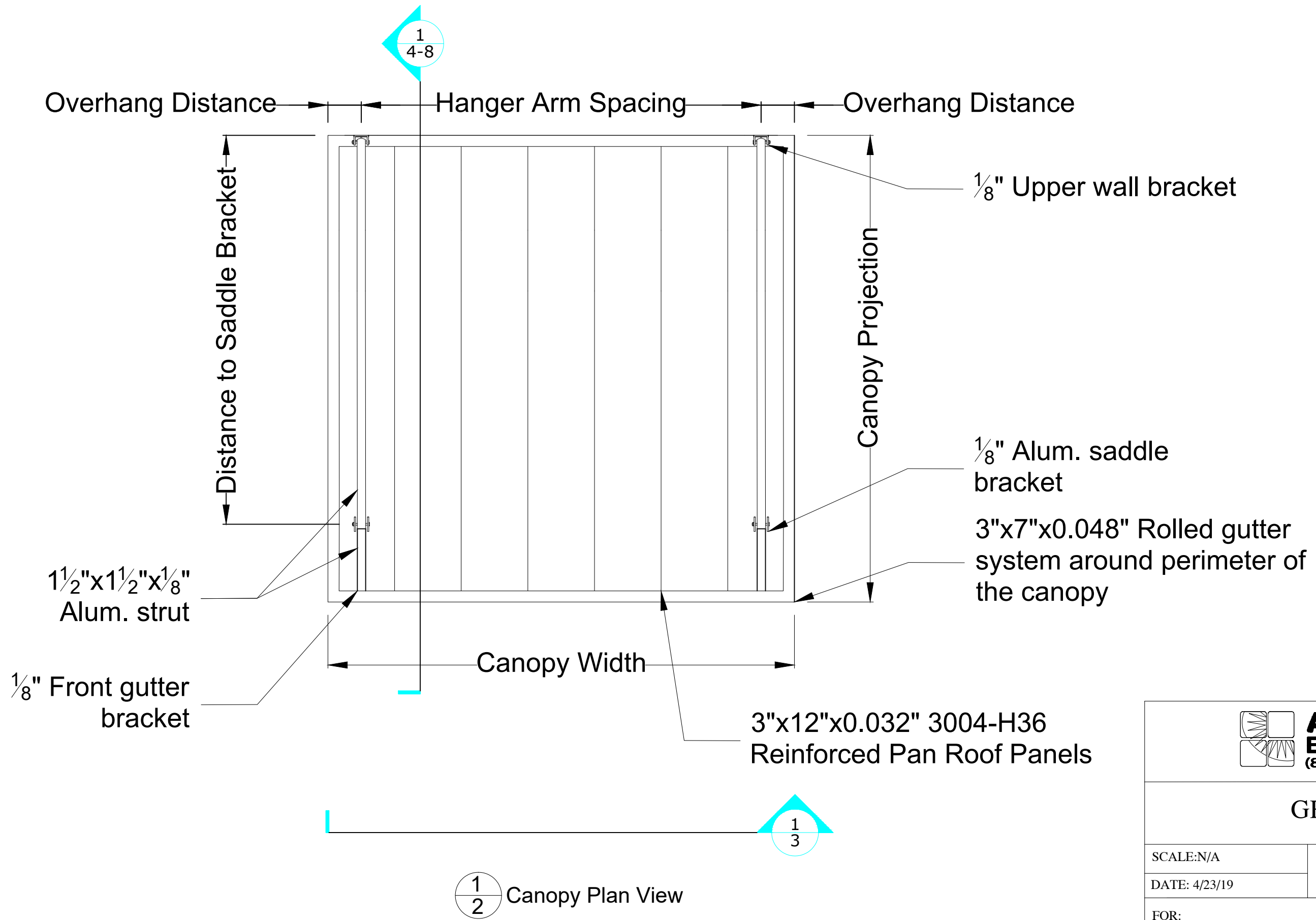

GHRC-100

SCALE:N/A	APPROVED BY:	DRAWN BY: ES
DATE: 4/23/19		REVISION:
FOR:		Drawing Number: 2 of 13

THESE DRAWINGS WERE PREPARED BY AND ARE THE SOLE PROPERTY OF AIR-VENT EXTERIORS. UNAUTHORIZED USE OR REPRODUCTIONS IS STRICTLY PROHIBITED. AIR-VENT EXTERIORS ©

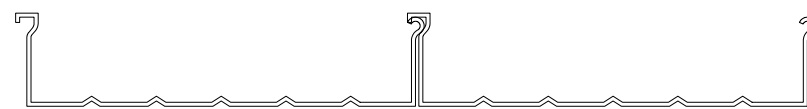
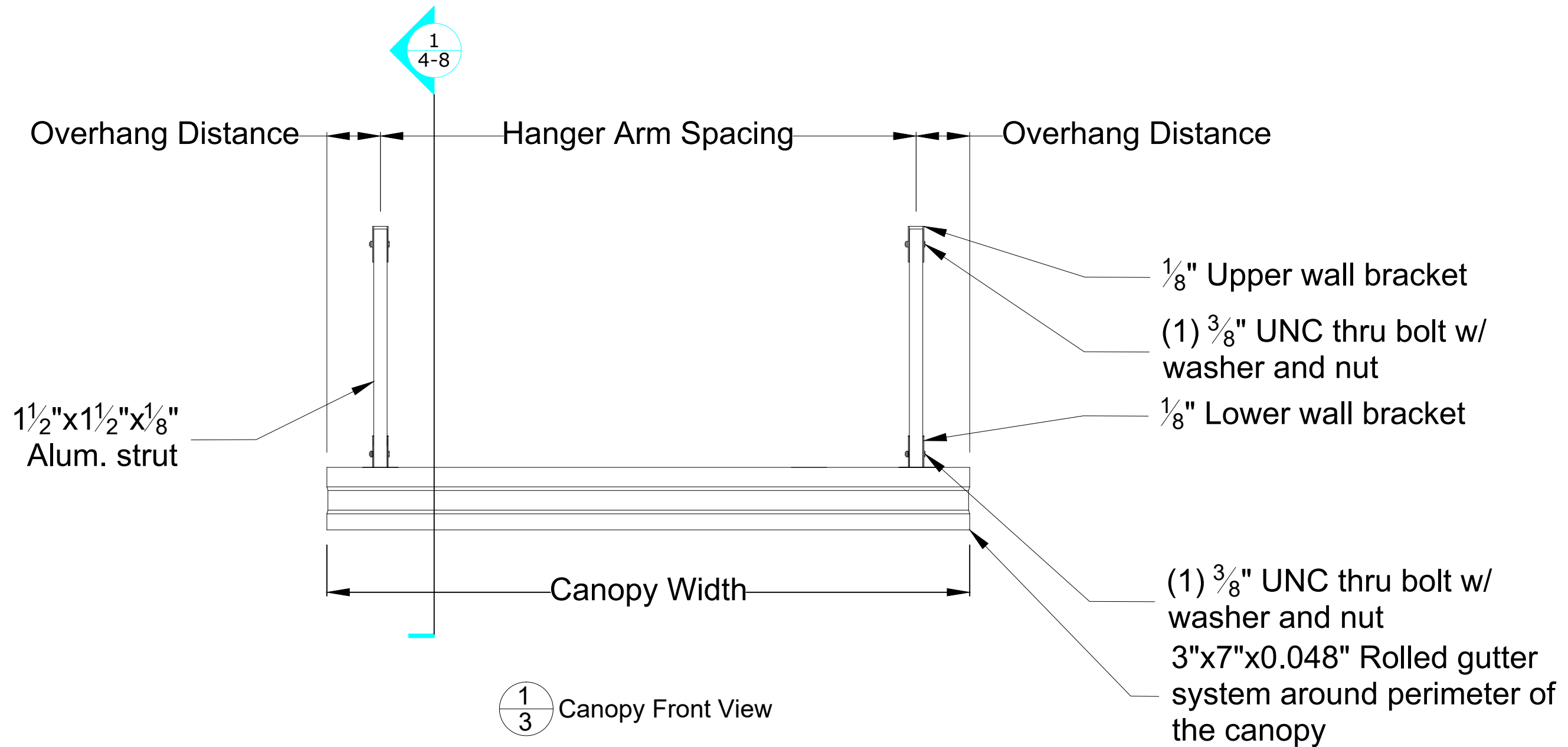

3"x12"x.032" 3004-H36 Reinforced Pan Roof Panels

2
3 Decking Detail



GHRC-100

SCALE: N/A	APPROVED BY:	DRAWN BY: ES
DATE: 4/23/19		REVISION:
FOR:		Drawing Number: 3 of 13

THESE DRAWINGS WERE PREPARED BY AND ARE THE SOLE PROPERTY OF AIR-VENT EXTERIORS. UNAUTHORIZED USE OR REPRODUCTIONS IS STRICTLY PROHIBITED. AIR-VENT EXTERIORS ©

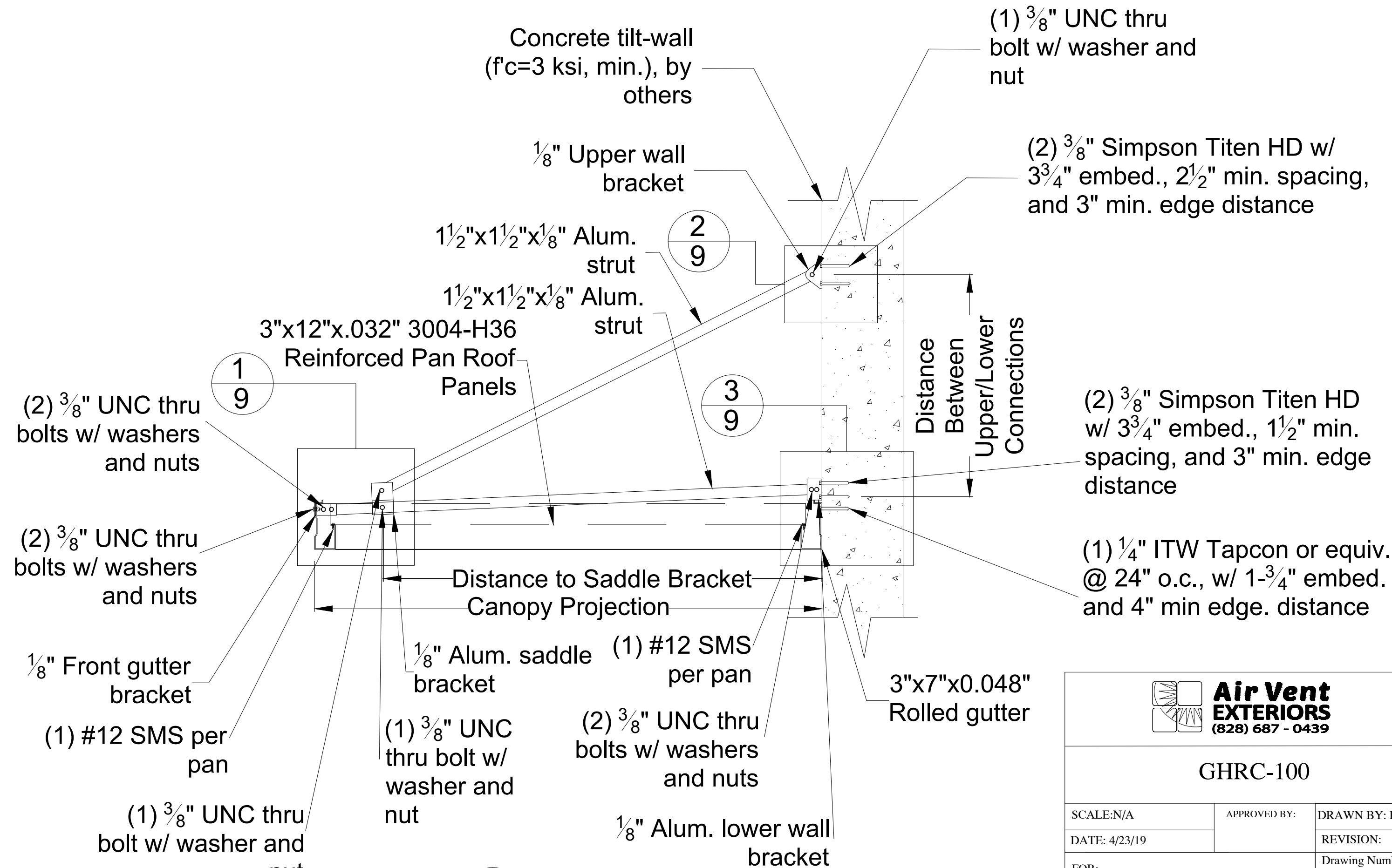

1 Canopy Section View
 4 Concrete Tilt Wall



Air Vent EXTERIORS
 (828) 687 - 0439

GHRC-100

SCALE:N/A	APPROVED BY:	DRAWN BY: ES
DATE: 4/23/19		REVISION:
FOR:		Drawing Number: 4 of 13

THESE DRAWINGS WERE PREPARED BY AND ARE THE SOLE PROPERTY OF AIR-VENT EXTERIORS. UNAUTHORIZED USE OR REPRODUCTIONS IS STRICTLY PROHIBITED. AIR-VENT EXTERIORS ©

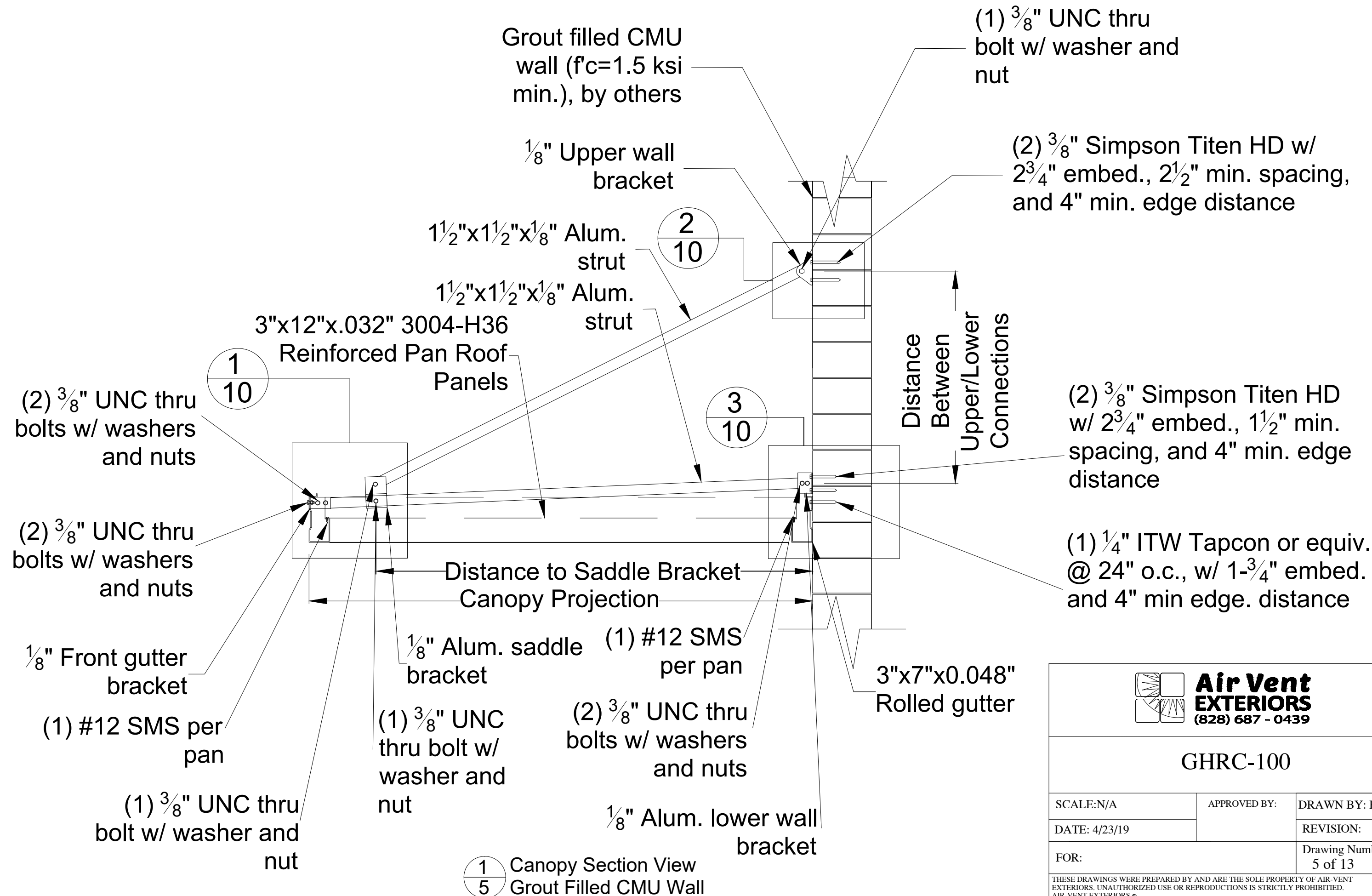

1 Canopy Section View
5 Grout Filled CMU Wall

 <p>Air Vent EXTERIORS (828) 687 - 0439</p>		
GHRC-100		
SCALE: N/A	APPROVED BY:	DRAWN BY: ES
DATE: 4/23/19		REVISION:
FOR:		Drawing Number: 5 of 13
<small>THESE DRAWINGS WERE PREPARED BY AND ARE THE SOLE PROPERTY OF AIR-VENT EXTERIORS. UNAUTHORIZED USE OR REPRODUCTIONS IS STRICTLY PROHIBITED. AIR-VENT EXTERIORS ©</small>		

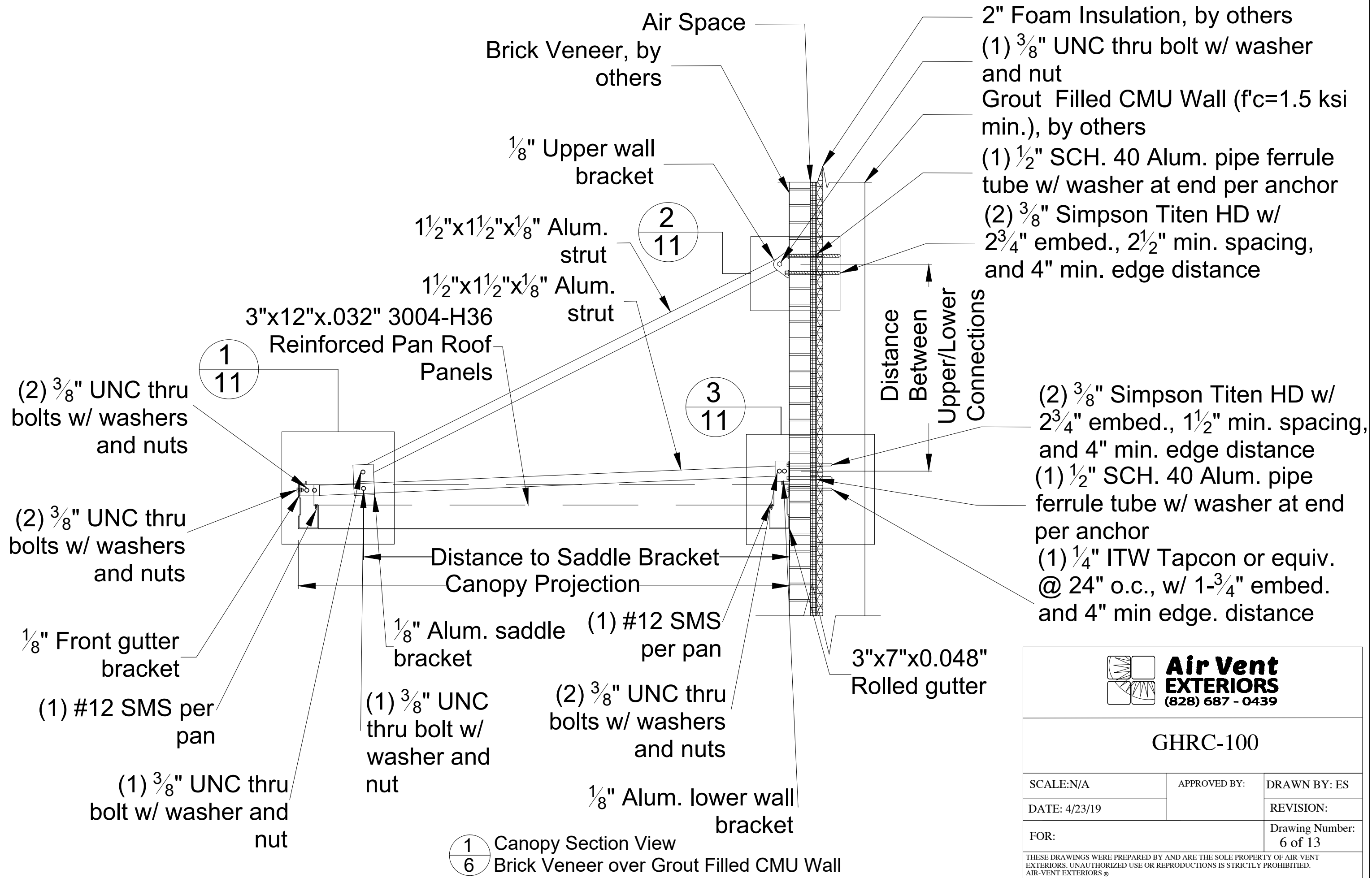

GHRC-100

SCALE:N/A	APPROVED BY:	DRAWN BY: ES
DATE: 4/23/19		REVISION:
FOR:		Drawing Number: 6 of 13

THESE DRAWINGS WERE PREPARED BY AND ARE THE SOLE PROPERTY OF AIR-VENT EXTERIORS. UNAUTHORIZED USE OR REPRODUCTIONS IS STRICTLY PROHIBITED. AIR-VENT EXTERIORS ©

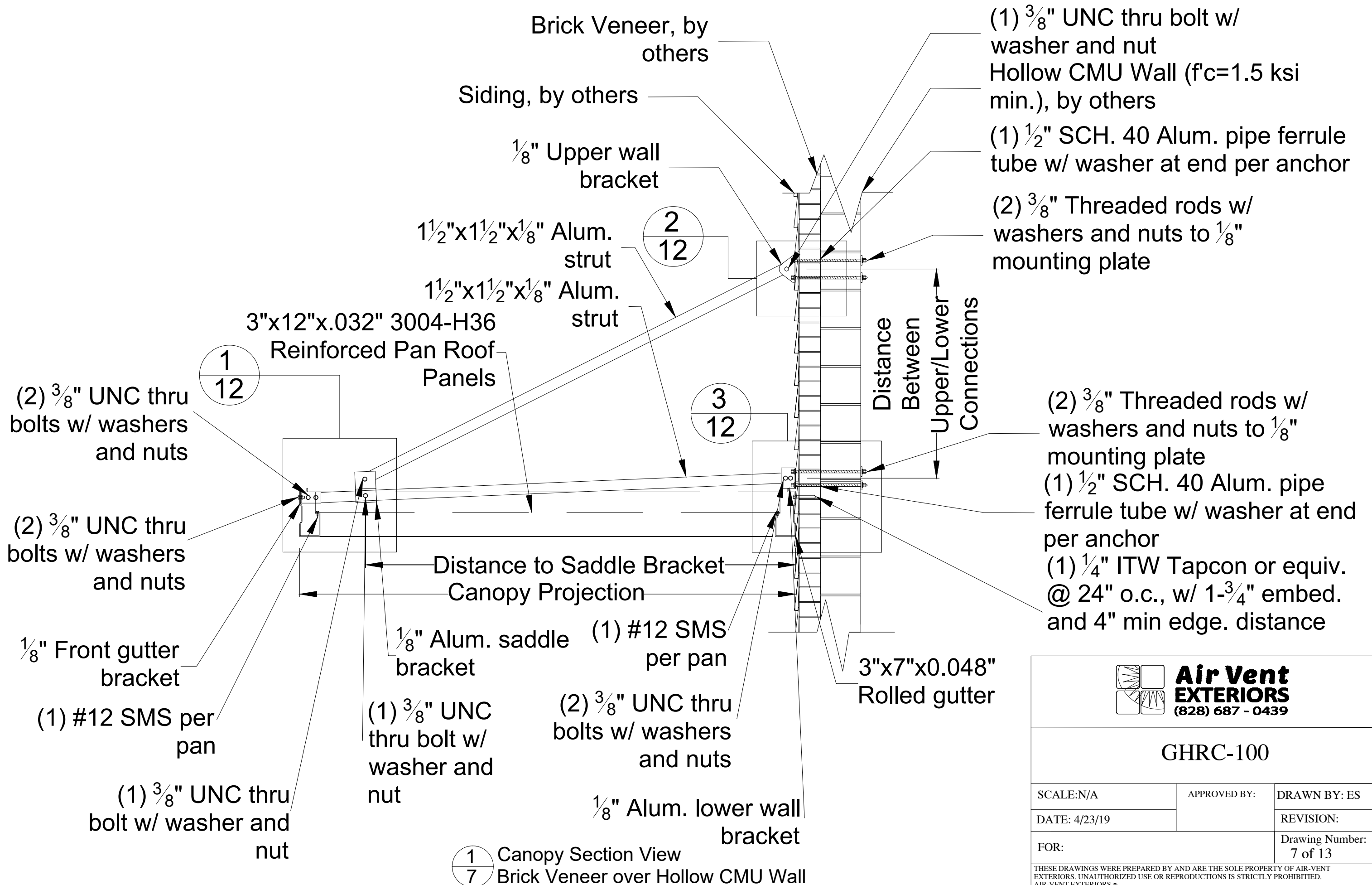

GHRC-100

SCALE:N/A	APPROVED BY:	DRAWN BY: ES
DATE: 4/23/19		REVISION:
FOR:		Drawing Number: 7 of 13

THESE DRAWINGS WERE PREPARED BY AND ARE THE SOLE PROPERTY OF AIR-VENT EXTERIORS. UNAUTHORIZED USE OR REPRODUCTIONS IS STRICTLY PROHIBITED. AIR-VENT EXTERIORS ©

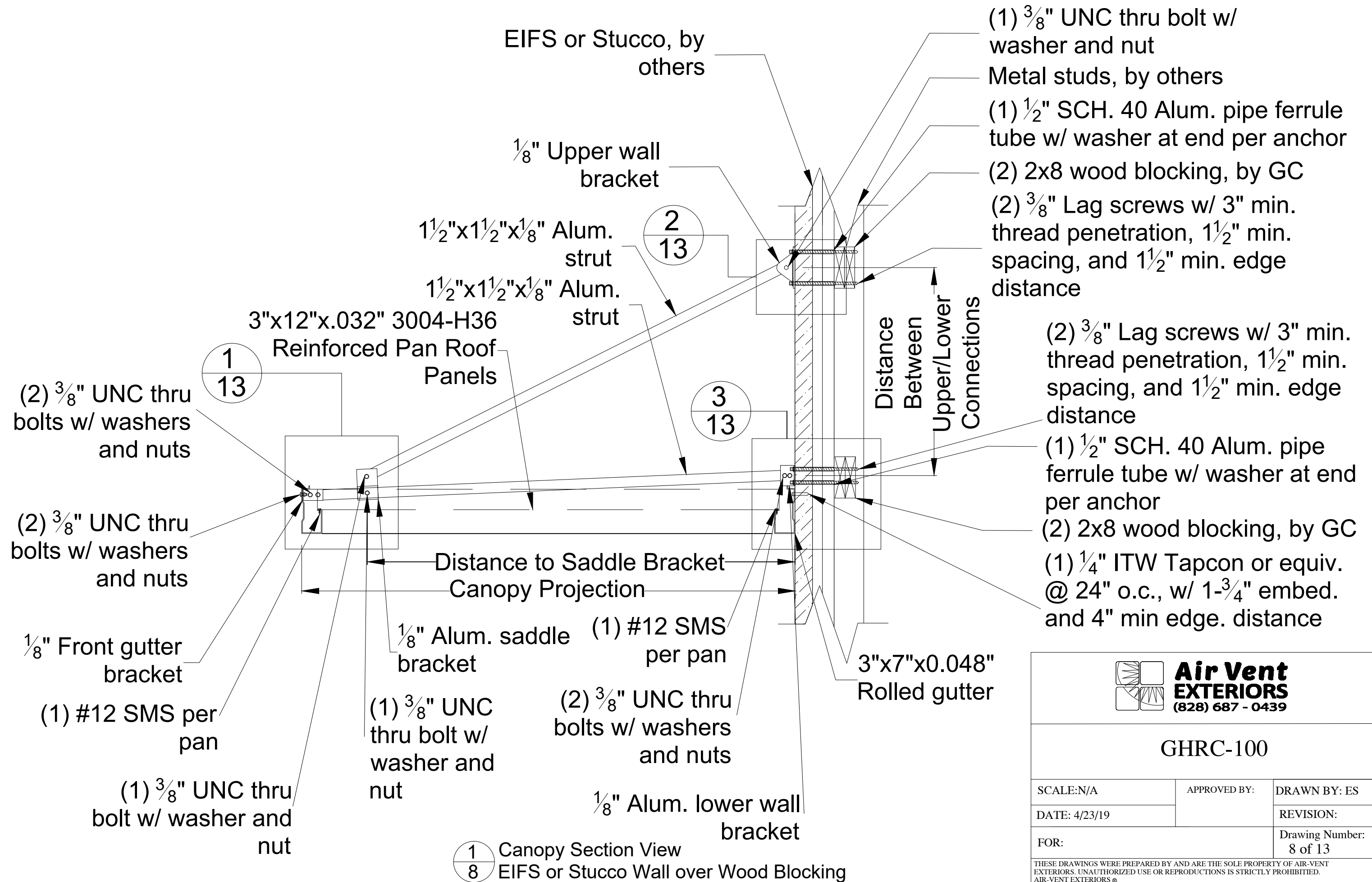

GHRC-100

SCALE:N/A	APPROVED BY:	DRAWN BY: ES
DATE: 4/23/19		REVISION:
FOR:	Drawing Number: 8 of 13	

THESE DRAWINGS WERE PREPARED BY AND ARE THE SOLE PROPERTY OF AIR-VENT EXTERIORS. UNAUTHORIZED USE OR REPRODUCTIONS IS STRICTLY PROHIBITED. AIR-VENT EXTERIORS ©

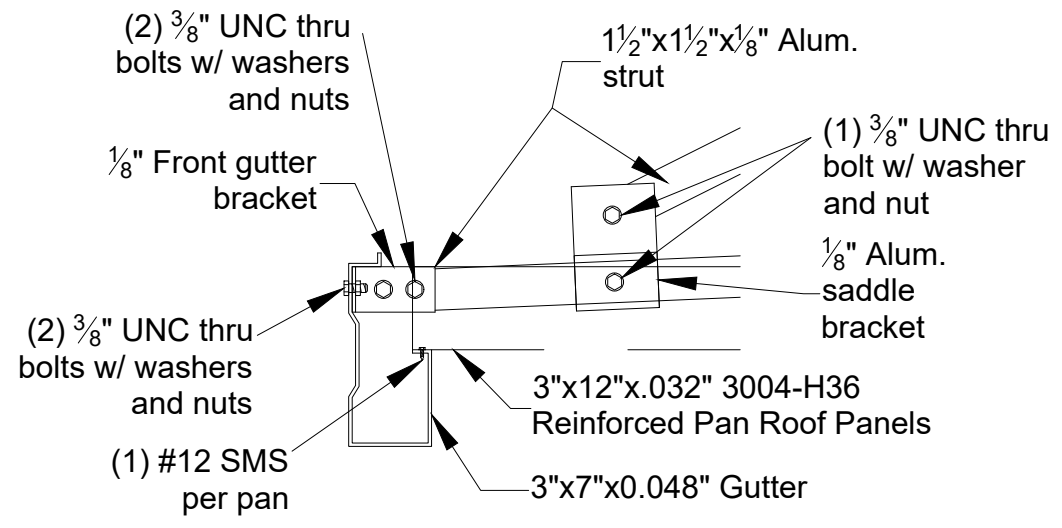

1/9 Front Gutter Detail

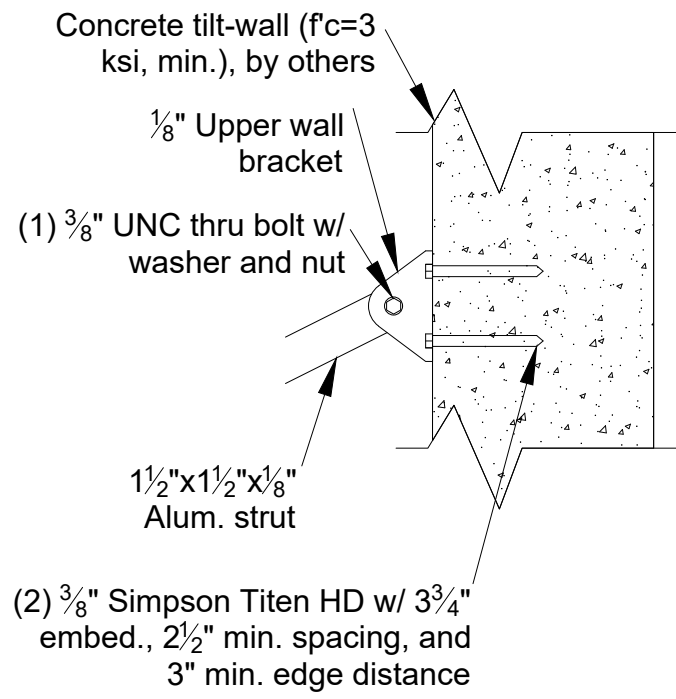

2/9 Wall Bracket Detail

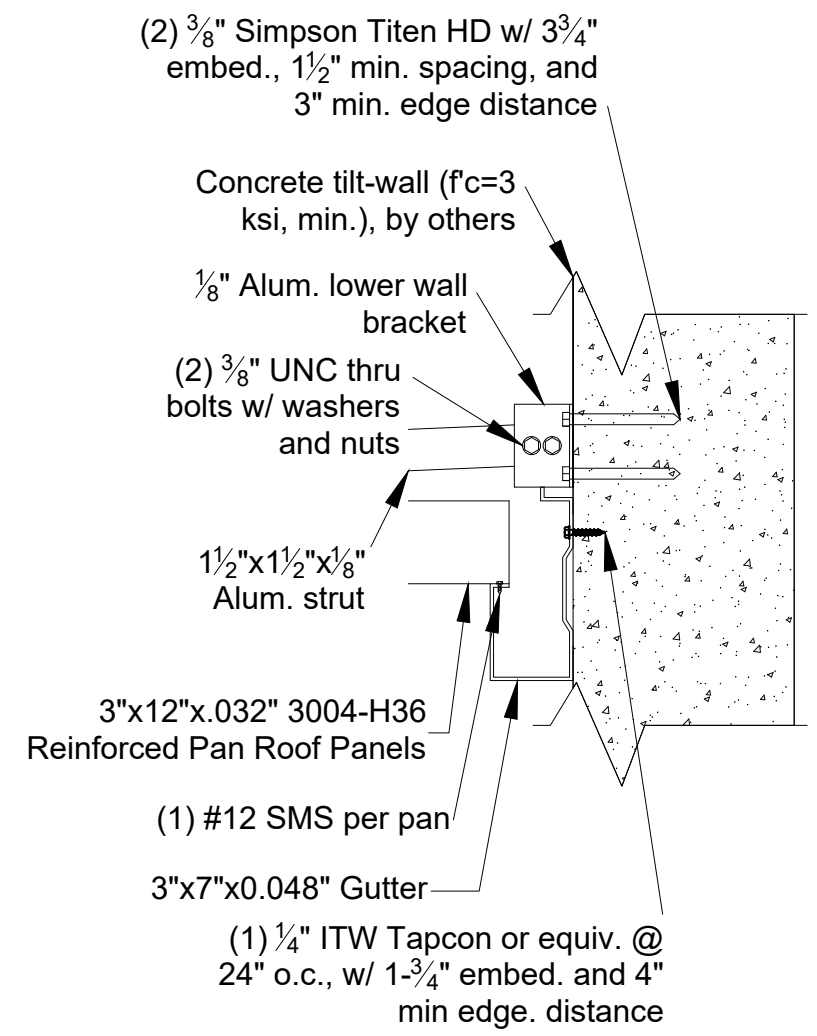

3/9 Rear Gutter Detail



GHRC-100

SCALE:N/A	APPROVED BY:	DRAWN BY: ES
DATE: 4/23/19		REVISION:
FOR:		Drawing Number: 9 of 13

THESE DRAWINGS WERE PREPARED BY AND ARE THE SOLE PROPERTY OF AIR-VENT EXTERIORS. UNAUTHORIZED USE OR REPRODUCTIONS IS STRICTLY PROHIBITED. AIR-VENT EXTERIORS ©

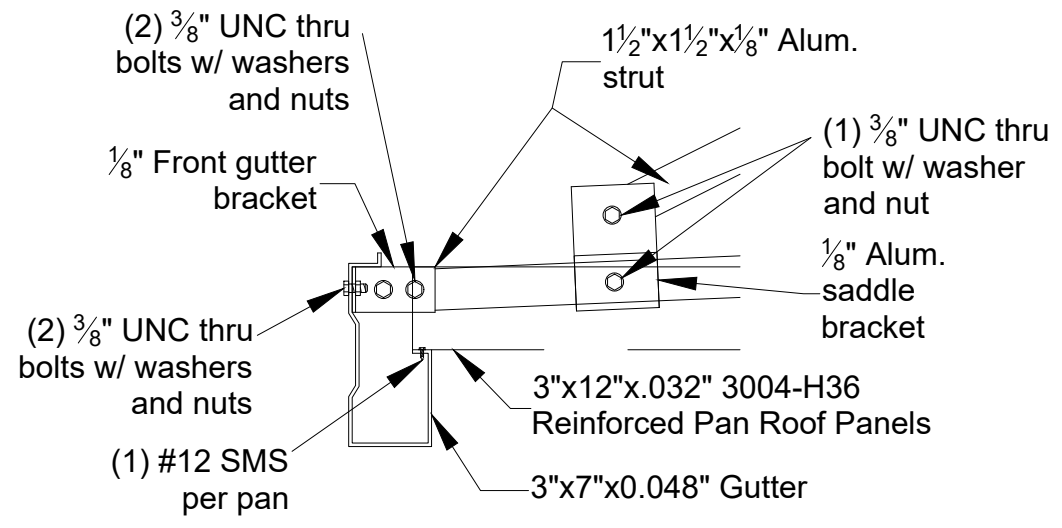

1/10 Front Gutter Detail

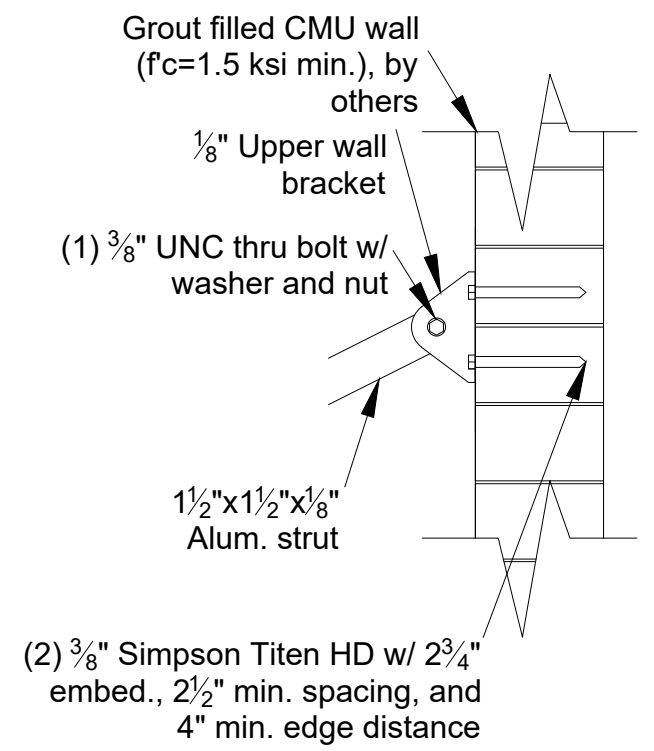

2/10 Wall Bracket Detail

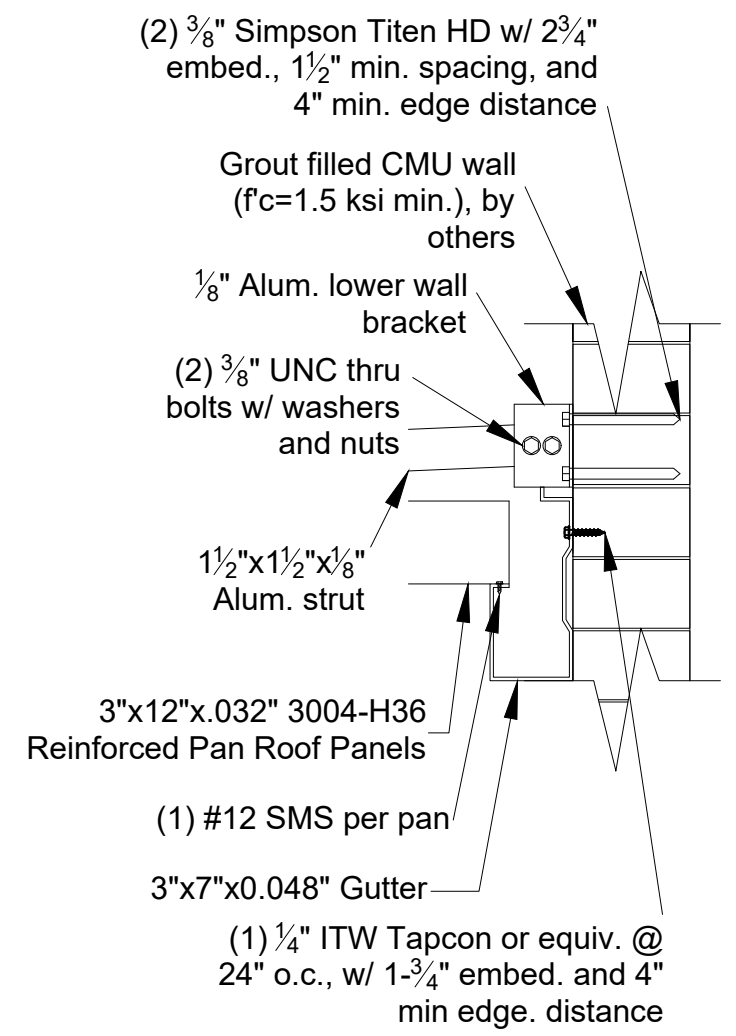

3/10 Rear Gutter Detail



GHRC-100

SCALE:N/A	APPROVED BY:	DRAWN BY: ES
DATE: 4/23/19		REVISION:
FOR:	Drawing Number: 10 of 13	

THESE DRAWINGS WERE PREPARED BY AND ARE THE SOLE PROPERTY OF AIR-VENT EXTERIORS. UNAUTHORIZED USE OR REPRODUCTIONS IS STRICTLY PROHIBITED. AIR-VENT EXTERIORS ©

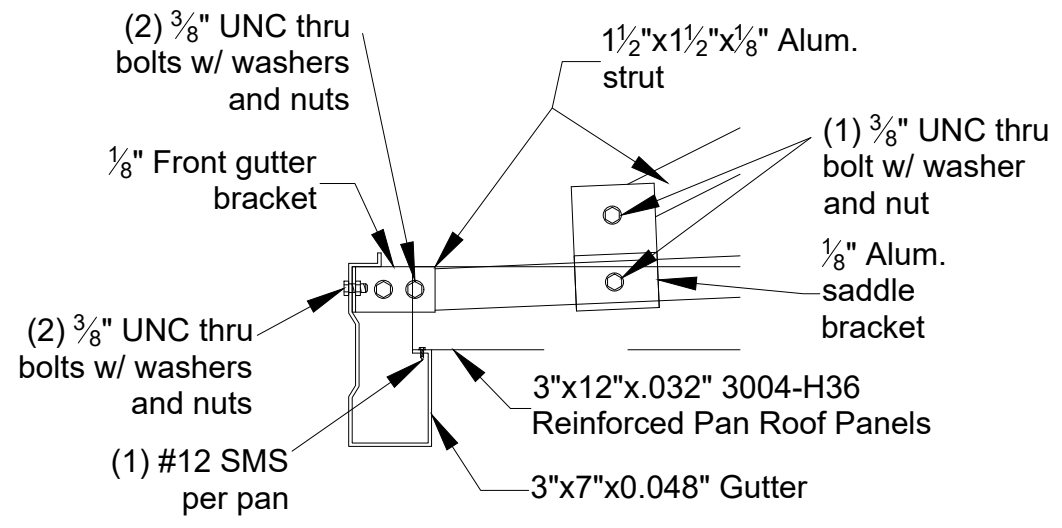

1/11 Front Gutter Detail

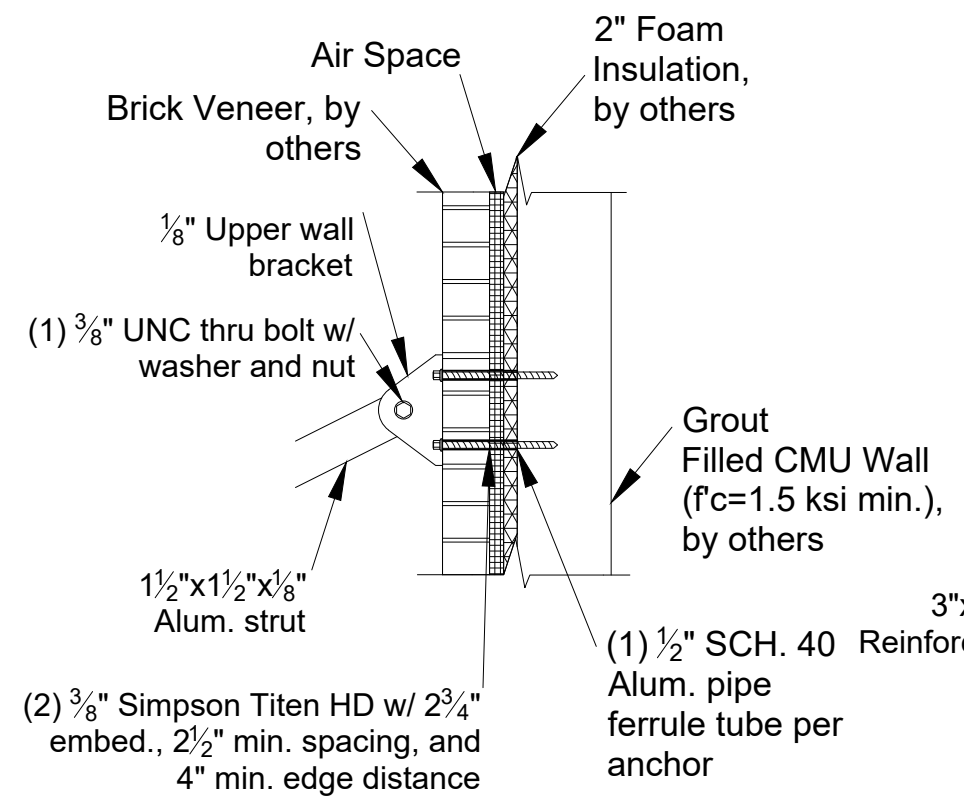

2/11 Wall Bracket Detail

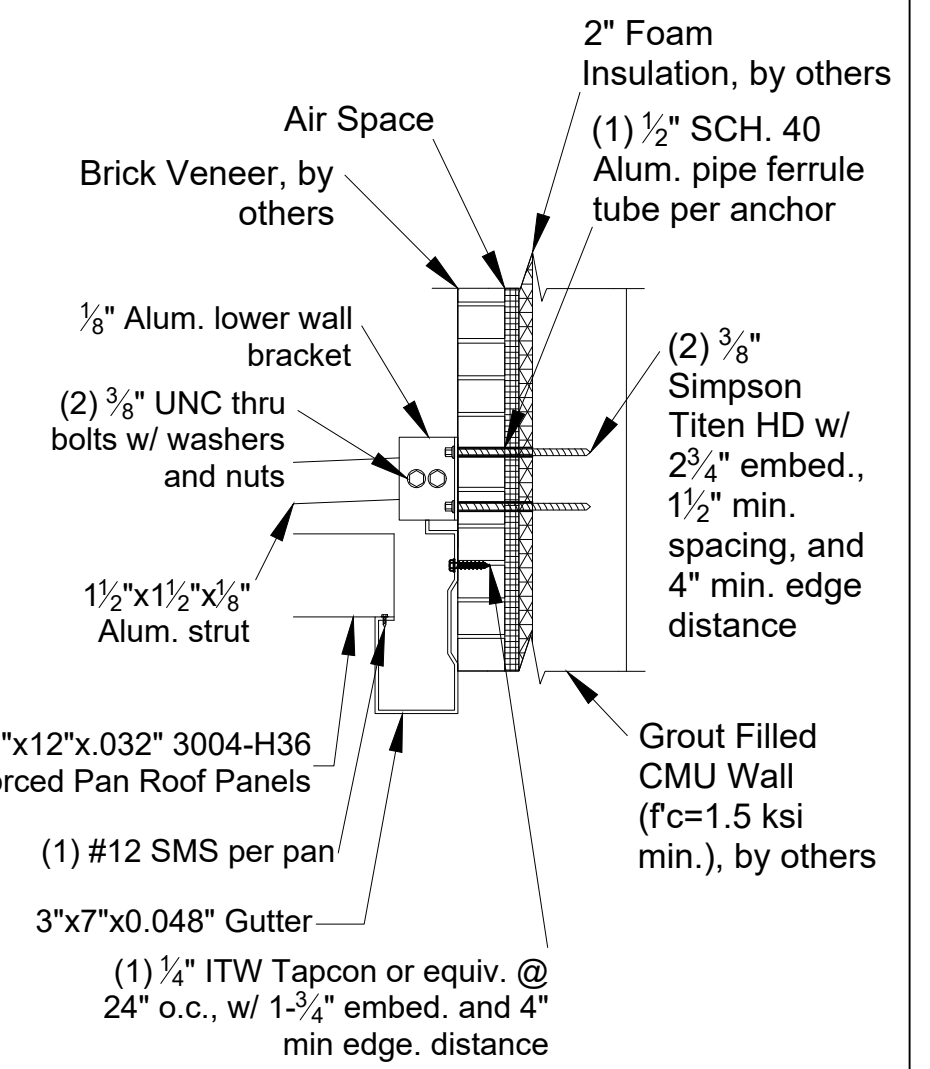

3/11 Rear Gutter Detail



GHRC-100

SCALE: N/A	APPROVED BY:	DRAWN BY: ES
DATE: 4/23/19		REVISION:
FOR:		Drawing Number: 11 of 13

THESE DRAWINGS WERE PREPARED BY AND ARE THE SOLE PROPERTY OF AIR-VENT EXTERIORS. UNAUTHORIZED USE OR REPRODUCTIONS IS STRICTLY PROHIBITED. AIR-VENT EXTERIORS ©

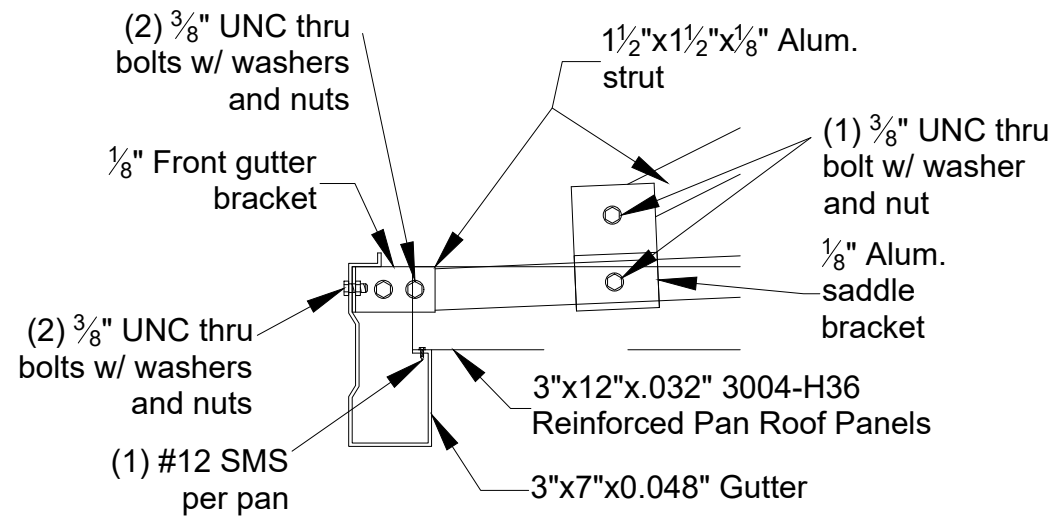

1/12 Front Gutter Detail

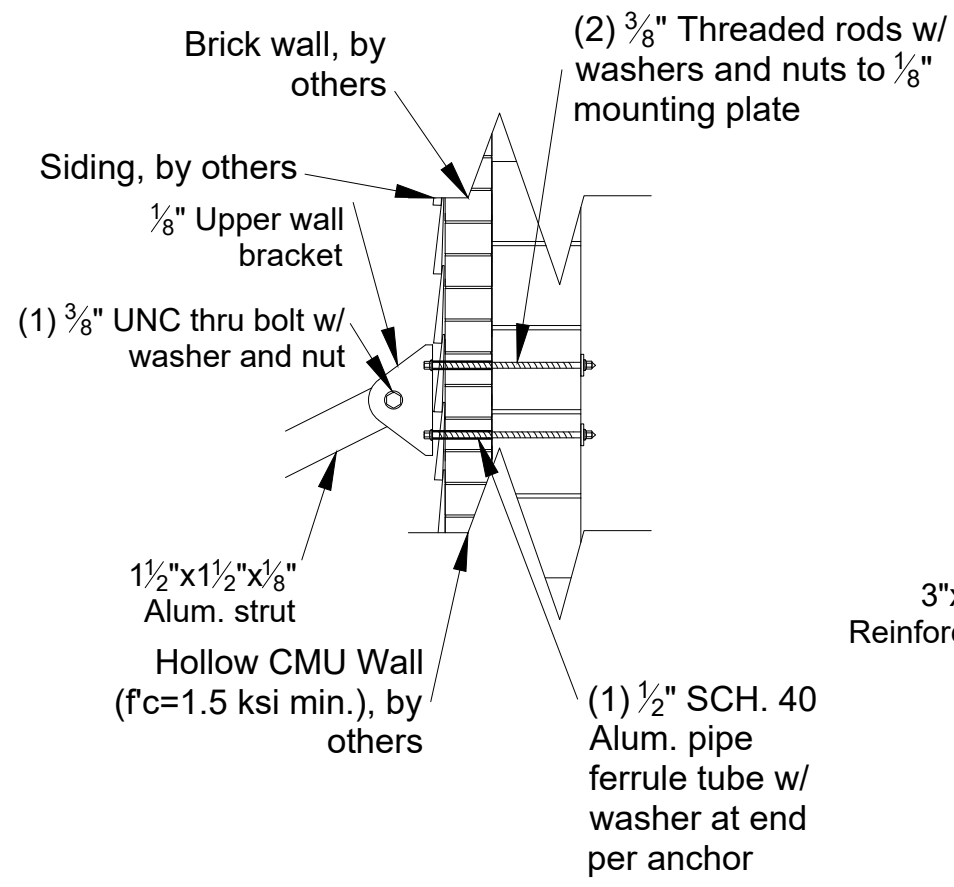

2/12 Wall Bracket Detail

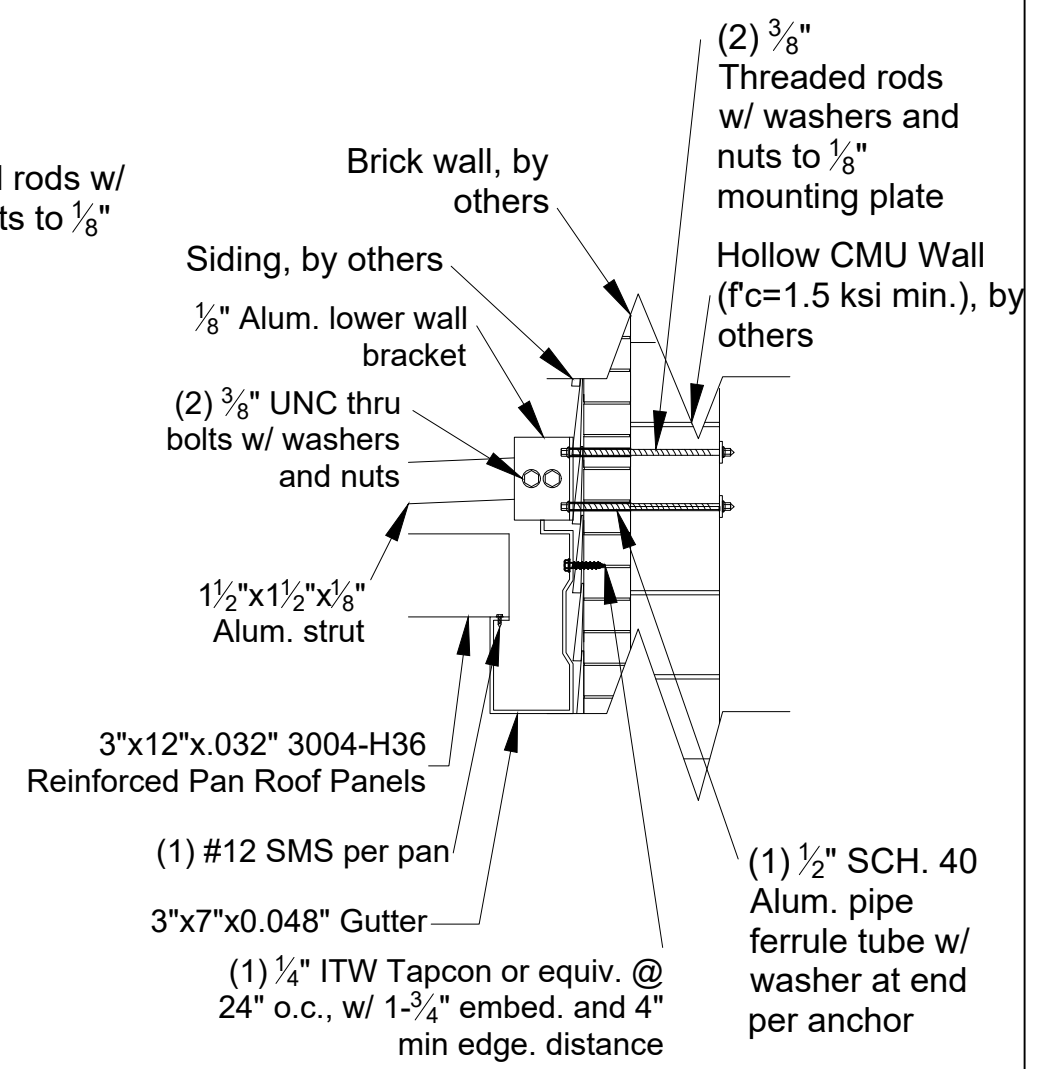

3/12 Rear Gutter Detail



GHRC-100

SCALE:N/A	APPROVED BY:	DRAWN BY: ES
DATE: 4/23/19		REVISION:
FOR:		Drawing Number: 12 of 13

THESE DRAWINGS WERE PREPARED BY AND ARE THE SOLE PROPERTY OF AIR-VENT EXTERIORS. UNAUTHORIZED USE OR REPRODUCTIONS IS STRICTLY PROHIBITED. AIR-VENT EXTERIORS ©

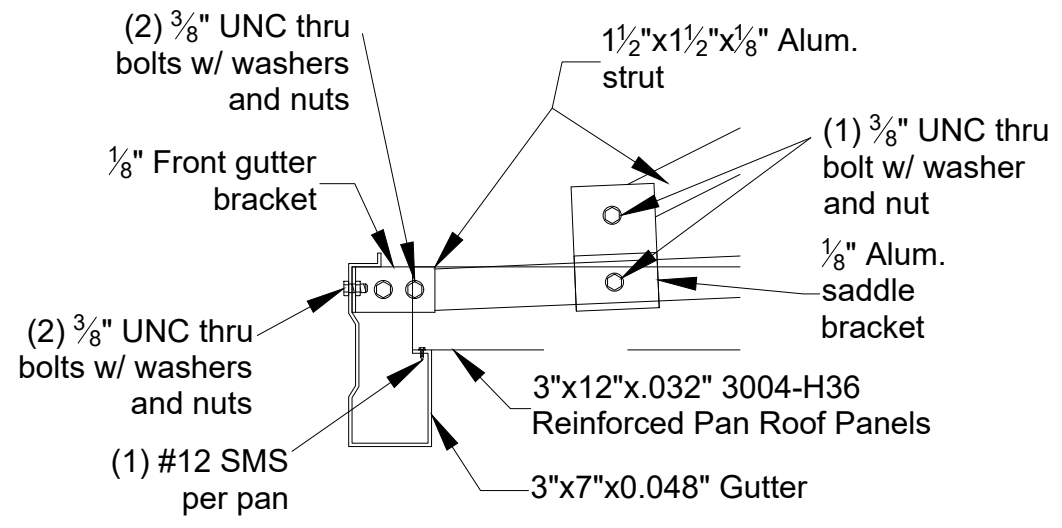

1/13 Front Gutter Detail

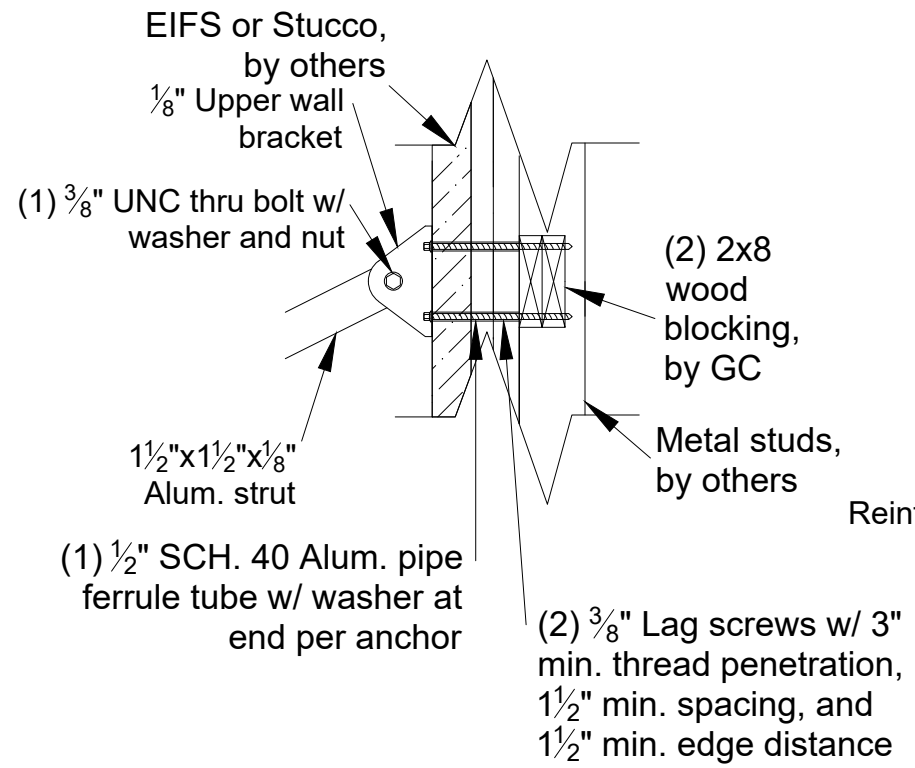

2/13 Wall Bracket Detail

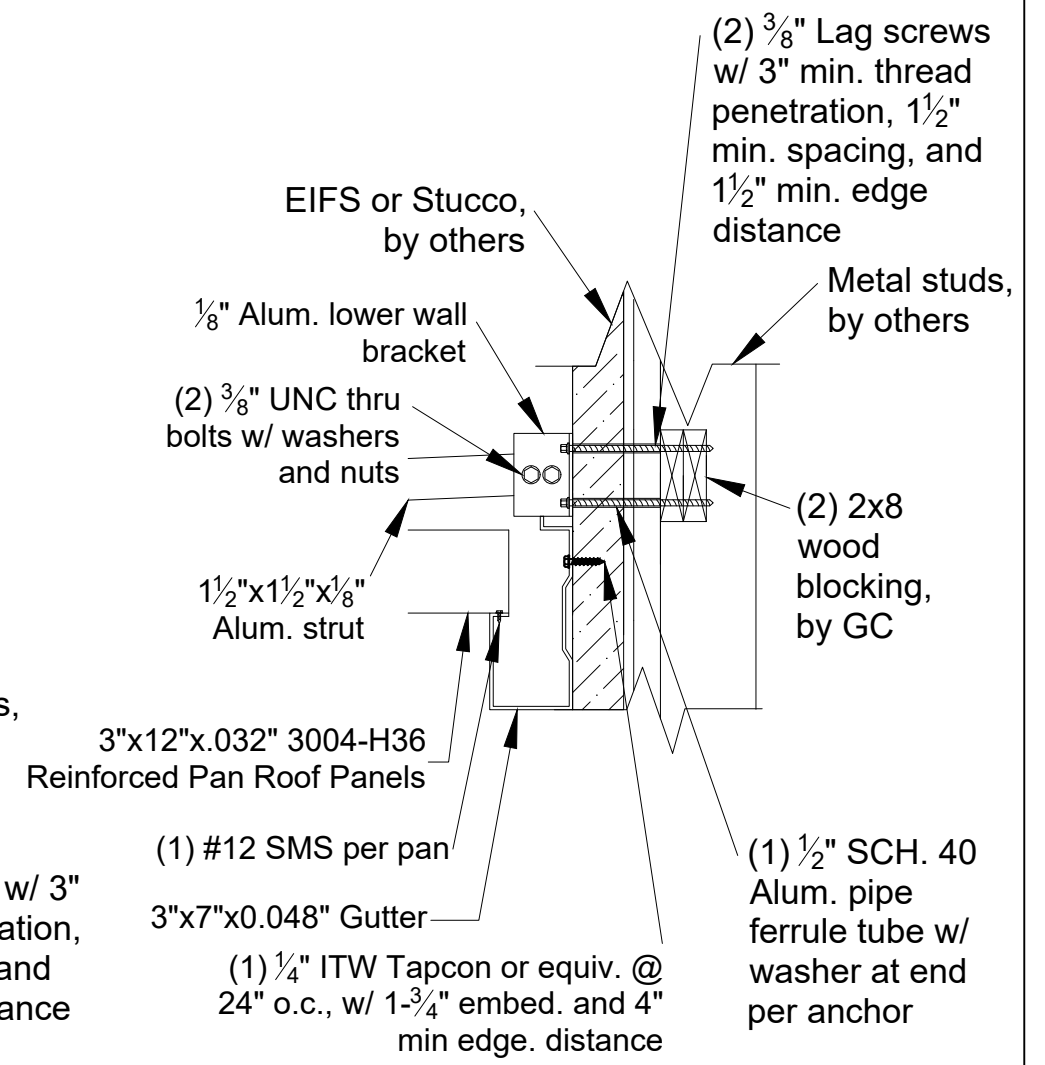

3/13 Rear Gutter Detail



GHRC-100

SCALE:N/A	APPROVED BY:	DRAWN BY: ES
DATE: 4/23/19		REVISION:
FOR:		Drawing Number: 13 of 13

THESE DRAWINGS WERE PREPARED BY AND ARE THE SOLE PROPERTY OF AIR-VENT EXTERIORS. UNAUTHORIZED USE OR REPRODUCTIONS IS STRICTLY PROHIBITED. AIR-VENT EXTERIORS ©